



SHAMS DUBAI

CONNECTION GUIDELINES FOR DISTRIBUTED RENEWABLE RESOURCES GENERATION CONNECTED TO THE DISTRIBUTION NETWORK

VERSION 2.1 OCTOBER 2020

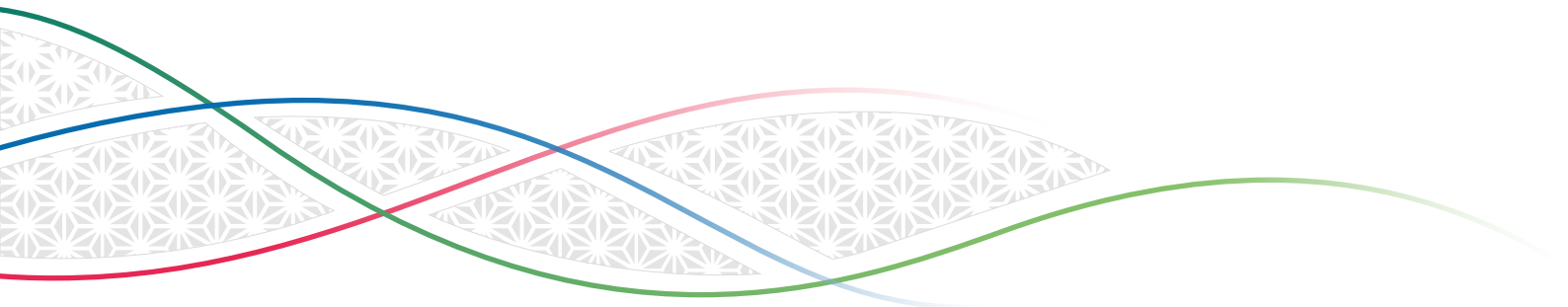

TABLE OF CONTENTS

1	INTRODUCTION.....	4
1.1	Scope	4
1.2	Definitions.....	4
1.3	Reference documents	8
2	PHOTOVOLTAIC INSTALLATION.....	9
2.1	Orientation and Inclination of PV modules	9
2.2	Equipment.....	10
2.2.1	Solar PV modules.....	10
2.2.2	Inverter	10
2.2.3	Metering System	11
2.2.4	Other equipment.....	11
2.3	PV array system configuration.....	12
2.3.1	PV system architectures and earthing.....	12
2.3.2	Series-parallel configuration of modules and strings.....	12
2.3.3	Use of inverters with single and multiple DC inputs	12
2.3.4	DC/AC converters (Microinverters) in combination with PV modules.....	13
2.3.5	Mechanical design.....	13
2.4	Safety issues.....	14
3	PV PLANT CONNECTION PROCESS.....	15
3.1	Engaging with Consultants/Contractors.....	16
3.1.1	Project Preparation	16
3.2	Consultant/Contractor applies for Solar PV Connection.....	16
3.2.1	Enrolment	16
3.2.2	Solar NOC Application	16
3.2.3	Solar Design Approval application	17
3.3	Technical Design Approval Download and Estimate of Applicable Connection Fees.....	19
3.3.1	Payment and Execution	19
3.4	Notification to DEWA by Consultant/Contractor for Inspection and Connection	19
3.4.1	Application for Mechanical Inspection	19
3.4.2	Application for Inspection and Connection and Post-Connection steps.....	19
3.5	Start of Production.....	22
4	DEFINITION OF THE RESPONSIBILITIES.....	23
4.1	DEWA	23
4.2	Customer/Producer.....	23
4.3	Consultant.....	24
4.4	Contractor	24
4.5	Manufacturers.....	24

APPENDIX A: CONNECTION SCHEMES	25
A.0 - General provisions.....	25
A.1 - LV1 Connection Scheme – One inverter $P_{MC} < 10 \text{ kW}$ (Interface Protection embedded in the inverter)	26
A.2 - LV2 Connection Scheme - One inverter $10 \text{ kW} \leq P_{MC} \leq 20 \text{ kW}$ (Interface Protection external to the inverter).....	27
A.3 - LV3 Connection Scheme - Multiple inverter ($10 \text{ kW} \leq P_{MC} \leq 20 \text{ kW}$).....	28
A.4 - LV4 Connection Scheme – Multiple inverter ($P_{MC} > 20 \text{ kW}$).....	29
A.5 - MV1 Connection Scheme - Interface Switch on LV side	30
A.6 - MV2 Connection Scheme - Interface Switch on MV side.....	31

1 INTRODUCTION

1.1 Scope

These Guidelines provide information meant for Dubai Residents, Consultants and Contractors on the essential aspects which have to be taken into consideration in order to connect a Renewable Resources Generating Plant (RRGP) to the Low (230/400 V) or Medium Voltage (6.6, 11 or 33 kV) Distribution Network.

It applies to the planning, execution, operation and modification of RRGPs, particularly to the Photovoltaic (PV) Generating Plants, also called Photovoltaic or Solar Plants.

The basic principles of this kind of plants, along with the illustration of the connection process are provided for the Dubai specific conditions.

Thus, this guide shall serve as a basis for DEWA and for the Customer or his appointed agent in the planning and decision-making process.

The technical aspects are not treated here, but separately in the **DEWA Standards For Distributed Renewable Resources Generators Connected to the Distribution Network**, (hereafter referred to as “the Standards”), which represents the main reference document for the definition of the requirements these generating facilities have to comply with in order to be connected to the Distribution Network.

This document provides additional information on specific aspects in order to clarify certain provisions of the Standards, in particular the connection schemes. This explanatory information is summarized in Appendix A.

1.2 Definitions

The most relevant definitions for the present Guidelines are listed below.

AC module - A PV module with an inverter mechanically secured to it so that the electrical output is a.c. and no d.c. plug/socket connections are in use between the module and the inverter.

Active Power - Active Power is the real component of the apparent power, expressed in watts or multiples thereof (e.g. kilowatts (kW) or megawatts (MW)). In the text this may be generically referred as P or P_n in case of rated active power of equipment.

Apparent Power - Is the product of voltage (in volts) and current (in amperes). It is usually expressed in kilovolt-amperes (kVA) or megavolt-amperes (MVA) and consists of a real component (Active Power) and an imaginary component (Reactive Power). In case of inverters, the rated apparent power corresponds to the maximum active power deliverable by the inverter at unity power factor.

Application for Connection - is filled by an Applicant for a new RRG Connection. This application shall be made through the Distributed Generation Application Form in the prescribed format and shall contain the required information.

Authorisation to Produce - Authorisation issued after the Final Inspection of the Renewable Resource Generating Plant.

Connection Agreement - The agreement between DEWA and a RRG, which stipulates the terms and conditions for the connection and operation of the Electricity Generator into the Power Distribution System and its operation.

Connection Point - Is the location at which Renewable Resource Generating Units, Renewable Resource Generating Plants as well as consumer loads are connected to the Network and where the Main Meter is installed. In the connection schemes this is also referred to as POC (Point Of Connection).

Consultant - A company enrolled with DEWA as Electrical & DRRG Solar PV Consultant, which carries out the design of Electrical facilities of all types including design of Solar PV plants.

Contractor - A company enrolled with DEWA as Electrical & DRRG Solar PV Contractor, which carries out Electrical Consulting/ Contracting works of all types including Solar PV plants. The Contractor may also perform design, supply equipment and materials or labour, especially for constructing, building and installing Solar PV plants.

Converter - Also called Power Converter. See Inverter

Current - Unless stated otherwise, current refers to the root-mean-square value of phase current.

Distribution System/Network - Is the medium (6.6, 11 or 33 kV) or low voltage (0.4 kV) electricity grid for supplying electricity to the end consumers.

DRRG - Distributed Renewable Resources Generation

Solar NOC - A NOC for the purpose of constructing a Solar PV plant.

Downstream - For a RRGP, "Downstream" means generator bound, e.g. towards the distribution network. "Upstream", instead, means the PV panel for a PV plant.

Generating Unit/Plant - A Generating Unit is an indivisible set of installations which can generate electrical energy. A set of Generating Units, circuits and auxiliary services for the generation of electrical energy forms a Generating Plant. See also the definition of "Renewable Resource Generating Unit/Plant".

Grid Connection: The connection of a Renewable Resource Generating Plant (RRGP) to the electrical grid.

Grid Connection fee: The fee to be paid for the connection to the grid.

Interface Protection - The electrical protection required to ensure that either the Generating Plant or the Generating Unit is disconnected for any event that could impair the integrity or degrade the safety of the Distribution Network.

Inverter - Device which converts the direct current produced by the photovoltaic modules to alternating current in order to deliver the output power to the grid. The inverter is also capable of controlling the quality of output power.

Isolated inverter - An inverter with, at least, simple separation between the main power output circuits and PV circuits (usually by means of a transformer) and with leakage currents less than the limits required to be classified as an isolated inverter (IEC 62109-2). The separation/ isolation may be either integral to the inverter or provided externally, e.g. an inverter with an external isolation transformer.

Non-isolated inverter - An inverter without the minimum separation between the main power output and PV circuits or with leakage currents greater than the requirements for an isolated inverter.

Junction box - Closed or protected connecting device where one or several junctions are performed.

Low Voltage (LV) Network - A Network with nominal voltage lower than 1kV.

Maximum Capacity - The maximum continuous Active Power which a Generating Plant can feed into the Network as agreed between DEWA and the Plant Producer. This corresponds to the sum of the maximum active power deliverable by the inverters at the AC side, that is also the sum of the rated power of the inverters at unity power factor (to be noted that this latter may

also be lower than the sum of the power at STC of the photovoltaic modules). In the text, this maximum capacity will also be indicated as P_{MC} .

Medium Voltage (MV) Network- A Network with nominal voltage included in the range from 1kV up to 33 kV. In Dubai, four voltage levels may be found on the MV distribution network, namely 6.6 – 11 – 22 – 33 kV. The 11 kV voltage level is the most used and diffused.

Main Electricity Meter - The main electricity meter installed at the Connection Point (DEWA side) and will perform the Net Metering of: i) the electricity delivered by the RRGp to the Distribution Network; and ii) the energy absorbed from the Distribution Network on a monthly basis.

Microinverter - An inverter that converts direct current produced by a single PV module to alternating current. The output from several microinverters is combined in order to deliver the output power to the grid.

PV Generation check-meter - Electricity meter installed at the common output point of all the Generating Units, to measure the total energy produced by the RRGp.

Network - Plant and apparatus connected together and operated by DEWA in order to transmit or distribute electrical power.

Non-Synchronously-Connected Renewable Resource Generating Unit - A Renewable Resource Generating Unit that is not electromagnetically directly connected to the Network. All types of installations that are fully connected to the Network through Power Electronic Converters, for instance photovoltaic power generating Units, fall into this category.

Overall duration: Total amount of time needed for project development until PV plant starts operating.

Peak Power (W_p) – The output power achieved by a Photovoltaic Module under Standard Test Conditions (STC). It is measured in W_p (W peak). The sum of the peak power of the photovoltaic modules of either a string or an array determines the peak power of the string and the array respectively (usually measured in kWp). The peak power of a photovoltaic array at STC is conventionally assumed as the rated power of the array.

Permission: A license to carry out an act that, without such licence, would be considered unlawful.

Photovoltaic (PV) cell – The most elementary device that exhibits the photovoltaic effect, i.e. the direct non-thermal conversion of radiant energy into electrical energy.

Photovoltaic (PV) Module – Also called Photovoltaic (PV) panel. The smallest, complete, environmentally protected assembly of interconnected cells.

Photovoltaic (PV) string – A circuit of one or more series-connected modules.

Photovoltaic (PV) string combiner box – A junction box where PV strings are connected which may also contain overcurrent protection devices and/or switch-disconnectors.

Photovoltaic (PV) array – Assembly of electrically interconnected PV modules, PV strings or PV sub-arrays.

Photovoltaic (PV) sub-array – An electrical subset of a PV array formed by parallel-connected PV strings.

Power Factor - Is the ratio of Active Power to Apparent Power.

Protective earthing – Earthing of a point in equipment or in a system for safety reasons.

Power Generating Plant (Power Plant) - Set of Generating Units, circuits and auxiliary services for the generation of electrical energy. In case of a Generating Plant made only of RRGU, a reference to RRGP will be made in this document.

P-Q-Capability Diagram - Describes the ability of a Generating Unit to provide Reactive Power in the context of varying Active Power and at the rated voltage.

Power Distribution System -The electrical network and its components which are owned and operated by DEWA with the main purpose of delivering electricity to consumers from the Power Transmission System. The 33kV and below voltage levels are considered a distribution system. The components of a Power Distribution system include all associated equipment including but not limited to interconnecting lines, electrical substations, pole mounted transformers, analogue electrical elements such as resistors, inductors, capacitors, diodes, switches and transistors.

Power Transmission System - The system belonging to DEWA which entirely or mainly comprises of the High-Voltage (> 33 kV) electricity cables, lines and electricity installations and facilities owned and/or operated by DEWA and used to transmit electricity from a power unit to a power substation or other electricity generation unit.

Process: A Process is one of the necessary functional procedures necessary to develop a PV system. A Process is described by a sequence of Process Steps (which may be of either administrative or technical nature).

Process Duration: The overall time needed to complete a specific process of the PV project lifecycle.

Process Step: A step is one of a sequential succession of actions that need to be executed in order to satisfy the legal-administrative and the other requirements of a process.

Producer: Any entity authorised by the Authority to produce electricity connected to the network in the Emirates. In other documents the term “Generator” may be used.

PV Project Lifecycle: All the procedures required to authorise, install and finally connect a PV system. The Project Lifecycle is defined as a sequential succession of Processes, each of them described by a sequence of Process Steps (either administrative or technical).

Reactive Power - Reactive Power is the imaginary component of the apparent power, usually expressed in kilovar (kVAr) or Megavar (MVar).

Representative - Any person representing or mandated to represent a party, including, but not limited to its directors, members of management, officers, employees, or professional advisors.

Renewable Resource Generating Plant (RRGP) - Is a set of Renewable Resource Generating Units.

Renewable Resource Generating Unit (RRGU) – Is a Generating Unit that produces power exclusively from renewable primary resources. This Renewable Resource Generating Unit can be part of a Generating Plant that includes non-renewable resources. In this latter situation, the Renewable Resource Generating Unit mentioned in the Standards is the part of the Plant that is able to produce energy without input from non-renewable resource. The Photovoltaic Generating Plant is illustrated below:

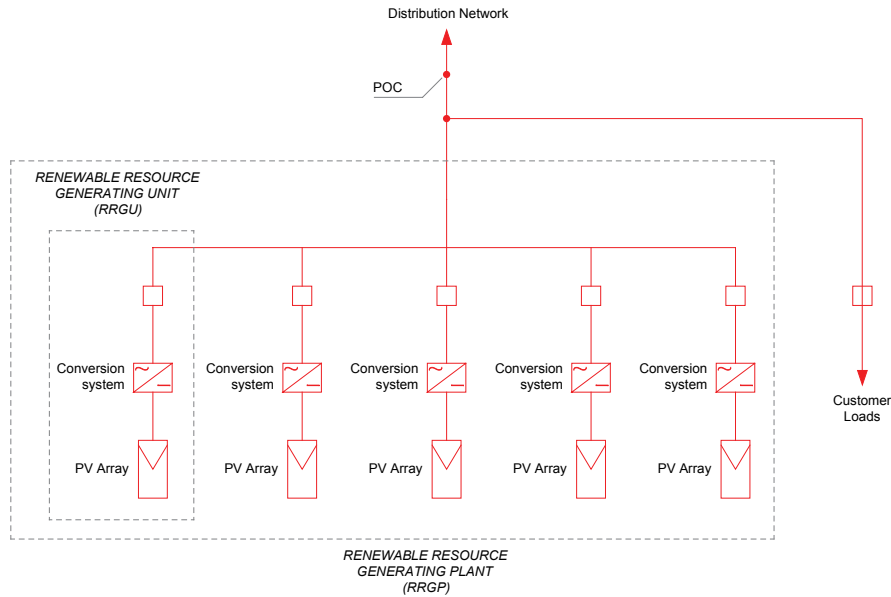

Standard test conditions (STC) – A standard set of reference conditions used for the testing and rating of photovoltaic cells and modules. The standard test conditions are:

- a) PV cell temperature of 25 °C;
- b) Irradiance in the plane of the PV cell or module of 1000 W/m²; and
- c) Light spectrum corresponding to an atmospheric air mass of 1,5.

Switch-disconnector - Mechanical switching device capable of making, carrying and breaking currents in normal circuit conditions and, when specified, in given operating overload conditions. In addition, it is able to carry, for a specified time, currents under specified abnormal circuit conditions, such as short-circuit conditions. Moreover, it complies with the requirements for a disconnector (isolator).

Test Engineer - A Contractor or a Consultant or a Licensed Engineer who is skilled and qualified for testing photovoltaic DRRG installations as certified by DEWA.

Upstream - See: Downstream

RRGP Voltage - Unless stated otherwise, voltage refers to the root-mean-square value of phase-to-phase voltages.

1.3 Reference documents

The following documents available on DEWA website www.dewa.gov.ae have been quoted:

- Standards For Distributed Renewable Resources Generators Connected To The Distribution Network (in the following only “Standards”)
- DEWA Regulations for Electrical Installations, 1997 Edition
- DEWA Distribution Substation Guideline, 2014 Edition
- DEWA Power Supply Guidelines for Major Projects, March 2013
- DEWA Design Requirements & Guidelines for MV (11kV-22kV) supply, December 2008
- DEWA Customer Guide, 3rd edition
- Safety of People: Recommendations for DRRG Solar PV, Edition 2015
- Safety of Environment: Recommendations for DRRG Solar PV, Edition 2015

2 PHOTOVOLTAIC INSTALLATION

2.1 Orientation and Inclination of PV modules

There are several factors to be accounted for when planning to install photovoltaic panels on rooftops. Considering the geometry of the PV array, these factors are (see Figure 1):

- Orientation of PV modules to the sun;
- Inclination (tilt) angle of PV modules; and
- Shadowing from objects or other buildings.

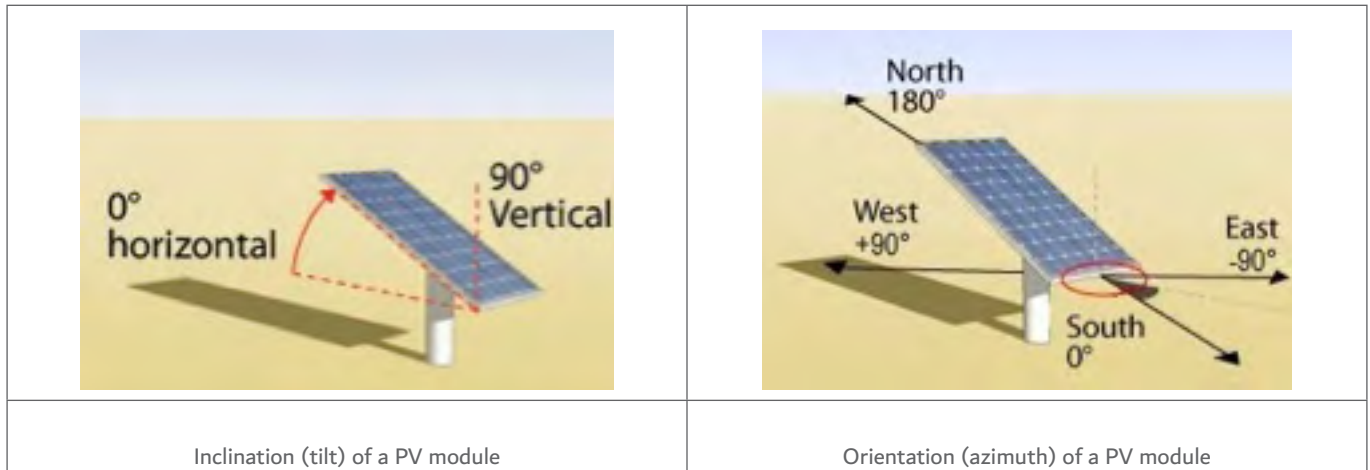

Figure 1 – Orientation and inclination of the PV panels

The favourable orientation (azimuth) for fixed solar cells in Dubai throughout the year is South (0° S) with an inclination (tilt) of about 24° with respect to the horizontal plane. This allows an average annual irradiation on a horizontal plane of about 2000-2100 kWh/m²yr for Dubai¹ when both the direct and diffused radiation are considered, which means about 1500-1800 kWh/yr per kWp installed.

Small variations around these values do not significantly affect the production. For instance, an energy reduction not greater than 5% can be noticed by maintaining a South orientation and varying the tilt from 5° (this value to be raised to 10° to allow a better cleaning) to 40° . It is also possible to stay below a 5% loss by varying the azimuth of PV modules from -60° to $+60^\circ$, if the tilt is maintained at 24° .

It is essential to avoid any shadows on the PV modules, because this can cause a substantial drop in the system performance. In contrast to solar thermal collectors, any shadow on a PV array causes a significant reduction of the power produced. Furthermore, especially in UAE, where the beam fraction of the solar radiation is high, partial shadowing on PV modules causes strain on shadowed PV cells which may, in turn, cause local temperature escalation (hot-spots) and may thus compromise the durability and safety of these components.

It is important that PV modules are kept clean and to avoid deposits of dirt and dust, since these reduce the efficiency of these components. The Emirate of Dubai is in a region prone to dusty desert environments and frequent dust storms, therefore, it is recommended to clean the PV system as to avoid dust, sand and dirt accumulation. A flatter position of PV modules may increase the deposits on PV modules and render their cleaning and washing more difficult, especially in case of large surfaces. It is therefore recommended to adopt a minimum tilt angle of at least 10° .

In a building, PV modules are usually installed on the roof in order to reduce shadowing and also to exploit surfaces often left unused. When possible, PV modules may be integrated in the building structure as Building Integrated Photovoltaic (BIPV) systems; these are frequently adopted to mitigate the visual impact of PV systems. Although often attractive from the point of view of aesthetics, PV facades (tilt = 90° or similar) are not recommended from an energy efficiency point of view, because their production is approximately 50% less than when optimally positioned.

¹ Data from Research Center for Renewable Energy Mapping and assessment atlas.masdar.ac.ae

2.2 Equipment

A typical renewable generation unit producing electricity has to be connected to a sub main distribution board or to the main distribution board and is usually composed of:

- Solar PV modules and their interconnections;
- Inverter(s);
- Metering System; and
- Electrical and mechanical installations (structures, cables, switchgears and controlgear assemblies).

The way this is connected to the network is explained in the connection schemes shown in Appendix A, according to the voltage level of the network itself.

The connection schemes also show another important element, namely the Interface Protection, which prevents the current of the plant from being injected into the network whenever a faulty event is detected on the latter. This protection may also be included in the inverter as specified in the Standards. The required protection functions are also specified in the Standards.

The switch on which the Interface Protection acts (Interface Switch) may also be used to disconnect the plant for maintenance purposes, without causing any shortages on the existing loads.

2.2.1 Solar PV modules

Solar PV modules can consist of PV cells of different technologies. In commercial and non-concentrating applications, single-crystalline and multi-crystalline cells achieve the maximum efficiency while thin-film technologies need more surface to produce the same power than their crystalline counterparts. Most manufacturers often guarantee a life time of 25 years or more, but they seldom take into account harsh conditions like those in Dubai. Furthermore, manufacturers indicate that PV modules undergo a loss of performance over time and therefore, a guaranteed efficiency is provided (e.g. usually 90 % after 10 years and 80 % after 25 years). However it is advisable to have a workmanship warranty of at least 10 years and, given the harsh conditions in Dubai, also a third party insurance backing for medium-large size plants (e.g. greater than 1 MW).

In general, Bypass diodes should be installed in order to prevent reverse bias in the PV modules and to avoid consequent hot spot heating.

PV modules are to be certified according to the compliance requirements defined in the Standards. The manufacturer shall then provide the Producer with certificates, proving that the PV modules are compliant with these requirements. The certification document will be requested by DEWA during the connection process. A list of the updated certified equipment is available at DEWA on request.

2.2.2 Inverter

The inverter converts the DC current produced by PV modules into AC current that can be used directly in the house/premises and/or injected into the external network. Ideally, the inverter should be located close to the photovoltaic modules to avoid losses, but this cannot always be possible because of the harsh outside conditions. High temperatures and dust in particular, require special caution in order to avoid any damage or performance reduction of the equipment.

It is therefore recommended to verify that the highest temperature to which the inverter can be exposed in summer does not cause any damage to it or reduce its life. Moreover, it is necessary to avoid high temperatures that may trigger any protection system aimed to reduce the internal temperature of the inverter by reducing its power (de-rating protection). If these conditions are not satisfied by mounting the inverter outside it is recommended to install the inverter in a safe room with enough ventilation and air conditioning, if necessary.

As specified in the Standards, the inverters shall be provided with an IP65 enclosure for outdoor application and IP54 enclosure for indoor application. In this latter case, lower protection grades shall only be permitted if the characteristics of the room will be properly conceived to protect the equipment (e.g. air conditioned rooms with means to avoid dust penetration). Whatever the case may be, the inverter shall be able to withstand the maximum temperatures with effective heating dispersion and with a power derating smaller than or equal to 25 % of its rated power as determined for an ambient temperature of 50 °C at the DC design voltage. This temperature is to be considered the maximum outdoor value at which all equipment, apparatus, materials and accessories used in electrical installations must be capable of operating with satisfactory performance in the climatic conditions of the emirate of Dubai. In addition, provisions which prevent the increase of the internal heating of the inverters shall be taken for outdoor installation (e.g. protections against direct exposition to the sun). For those inverters which do not comply with the above set rule, a placement in cooled room or enclosures with effective ventilation shall be required, inside which the ambient temperature will be kept below the value which determines a power derating equal to 25% of the inverter rated power at the DC design voltage.

2.2.3 Metering System

To measure the electricity generated by the renewable generation unit and electricity consumed by the house/ building, two bidirectional energy meters are usually installed:

1. The first bidirectional meter supplied and installed by DEWA in the Connection Point measures the power injected to the Distribution Network and the energy consumed from the Distribution Network. ("Main Electricity Meter"). This meter is already present in existing installations, however it shall be substituted by a smart meter if this has not already been done.
2. The second meter* supplied and installed by DEWA measures the electricity generated by the photovoltaic system (PV Generation check-meter).

During the connection process, the RRGp will be inspected by DEWA before the metering system can be installed. The inspection aims to ensure that the RRGp complies with the Standards and with safety rules.

2.2.4 Other equipment

All the components and equipment used in the PV plant shall comply with applicable standards and laws in force in Dubai. Any component or equipment that may introduce harmful or hazardous conditions shall be rejected.

All components and equipment is chosen adequately in order to assure its integrity and operation for a long lasting period. All equipment should be of an IP rating suitable for the location and this particularly applies to:

- Cables and connectors exposed to sunrays (UV in particular), external temperature and other weather conditions. This equipment is to be certificated for their application (e.g. solar cables). In DC circuits single-wire cables shall be used with different colours for the two poles: red for positive (+) and black or blue for negative (-).
- Switchgears and controlgear assembly shall be properly protected against temperature, sunrays (UV in particular), dust, salinity and all other weather conditions present on the site. Installation in a safe room is recommended. Their compliance to applicable standards shall be properly certificated (IEC 61439 series).

* The PV Generation check-meter can be waived for certain Shams Dubai projects < 10kW:

- In the case of villa communities having a large number of villas equipped with identical or similar small scale installations, the Generation check-meter is required only for a suitable sample of villas to be agreed with DEWA;
- In the case of individual buildings, provided the local area is not already saturated with other similar installations

-
- PV string combiner boxes shall be properly protected against temperature, sunrays (UV in particular), dust, salinity and all other weather conditions present on the site. Their location shall be visible without obstacle to their inspection and replacement of components (e.g. fuses). Their compliance to applicable standards shall be properly certificated (IEC 61439 series where applicable).

2.3 PV array system configuration

2.3.1 PV system architectures and earthing

The relation of a PV array to earth is determined by whether any earthing of the array for functional reasons is in use, the impedance of that connection and also by the earth status of the circuit. This and the location of the earth connection all affect safety for the PV array. The requirements and recommendations of manufacturers of PV modules and manufacturers of inverters to which the PV array is connected will be taken into account when determining the most appropriate system earthing arrangement.

Protective earthing of any of the conductors of the PV array is not permitted. earthing of one of the conductors of the PV array for functional reasons is not allowed, unless there is at least simple separation from mains earth provided, either internally in the inverter or externally via a separate transformer.

Earthing of PV module frames and supporting metallic structures shall be executed according to IEC/TS 62548 and other applicable standards. All earthing connections in the PV plant (DC and AC sections) shall be part of a unique earthing system, i.e. a proper bonding shall be assured.

2.3.2 Series-parallel configuration of modules and strings

All PV strings within a PV array connected in parallel are to be of the same technology and have the same number of series connected PV modules. In addition, all PV modules in parallel within the PV array shall have similar rated electrical characteristics, including short circuit current, open circuit voltage, maximum power current, maximum power voltage and rated power (all at STC).

It is important that the characteristics of any array or sub-array be fully compatible with the input characteristics of the inverter used. This in particular applies to:

- Rated power at STC;
- Minimum and maximum voltage at any operating condition (solar radiation, air temperature); and
- Maximum system voltage.

2.3.3 Use of inverters with single and multiple DC inputs

PV arrays are often connected to inverters with multiple DC inputs. If multiple DC inputs are in use, overcurrent protection and cable sizing within the various sections of the PV array(s) are critically dependent on the limiting of any back-feed currents (i.e. currents from the inverter out into the array) provided by the input circuits of the inverter.

Where an inverter input circuit provides separate maximum power point tracking (MPPT) inputs, the overcurrent protection of the sub-array connected to the inputs shall take into account any back-feed currents. Each PV section connected to an input must be treated as a separate PV sub-array. Each PV array or sub-array shall have a switch-disconnector to provide isolation of the inverter.

2.3.4 DC/AC converters (Microinverters) in combination with PV modules

Microinverters are electrically connected to PV modules through direct wirings and may be used as:

- Permanently mounted close to the PV module but not mounted to or in direct contact with the module backsheet (also called Detached Microinverters). DC wiring are thus accessible to service personnel, although is deemed to be not user-accessible.
- Permanently mounted to the PV module's backsheet for both electrical and mechanical means of connection (AC modules).

Differently from classical PV arrays, in PV systems that use microinverters the connections in the array are made by using one or more AC parallel wiring systems (AC bus).

Instructions of manufacturers shall be applied especially as regards bonding/earthing of microinverters and in order to avoid overloads on AC wiring. In particular, AC cables shall have a proper voltage rate and, unless they are adequately protected, they shall be resistant to high temperatures, UV rays and other possible mechanical stresses.

In case of detached microinverters, attention has to be paid to the characteristics of DC connectors when used as a means to disconnect the DC circuit. When not rated to disconnect under load, all the necessary precautions have to be taken before disconnecting them (e.g. covering of the module).

2.3.5 Mechanical design

Support structures and module mounting arrangements shall comply with applicable building code regulations and standards and module manufacturer's mounting requirements.

Provisions should be taken in the mounting arrangement of PV modules to allow for the maximum expansion/contraction of the modules under expected operating temperatures, according to the manufacturer's recommendations. Similar provisions should be taken for other applicable metallic components, including mounting structures, conduits and cable trays.

The PV array support structures shall comply with local standards, industry standards and regulations with respect to loading characteristics.

PV modules, module mounting frames, and the methods used for attaching frames to buildings shall be rated for the maximum expected wind speeds in Dubai according to local codes.

In assessing this component, the wind speed observed (or known) on site shall be used, with due consideration to wind events (cyclones, tornadoes, hurricanes, etc.). The PV array structure shall be secured in an appropriate manner or in accordance with local building standards.

Wind force applied to the PV array will generate a significant load for building structures. This load should be accounted for in assessing the capability of the building to withstand the resulting forces.

Module mounting frames, and the methods used for attaching modules to frames and frames to buildings, shall be made from corrosion resistant materials suitable for the lifetime and duty of the system, e.g. aluminium, galvanized steel, zinc-coated steel, etc.

Aluminium, when used, shall be anodized to a thickness and specification suitable for the location and duty of the system. Corrosive gases such as ammonia, in farming environments also need to be contemplated.

Care shall be taken to prevent electrochemical corrosion between dissimilar metals. This may occur between structures and the building and also between structures, fasteners and PV modules.

Stand-off materials shall be used to reduce electrochemical corrosion between galvanically dissimilar metal surfaces; e.g. nylon washers, rubber insulators, etc.. Manufacturer's instructions and local codes should be consulted regarding the design of mounting systems and any other connections such as earthing systems.

2.4 Safety issues

In case the maximum PV array voltage, as calculated at the minimum outdoor temperature of 0°C, exceeds 1,000 Vdc, the entire PV array and associated wiring and protection shall have access restricted to competent persons only. PV arrays for installation on buildings shall not have maximum voltages greater than 1,000 Vdc.

The reader is addressed to the Standards where there is a detail of:

- Protection against electric shock and overcurrent:
 - Protection against electric shocks
 - Protection against overcurrent
 - PV string overcurrent protection
 - PV sub-array overcurrent protection
 - PV arrays with direct functional earth connections
- Array insulation resistance detection
- Protection by residual current monitoring system
- Earth fault protection on AC side
- Protection against effects of lightning and overvoltage
- Equipment marking and labeling

3 PV PLANT CONNECTION PROCESS

The procedure described in this part represents the steps that an Applicant must complete to get a Solar PV Plant connected to DEWA distribution network. The connection process consists of 4 different stages (see figure 2):

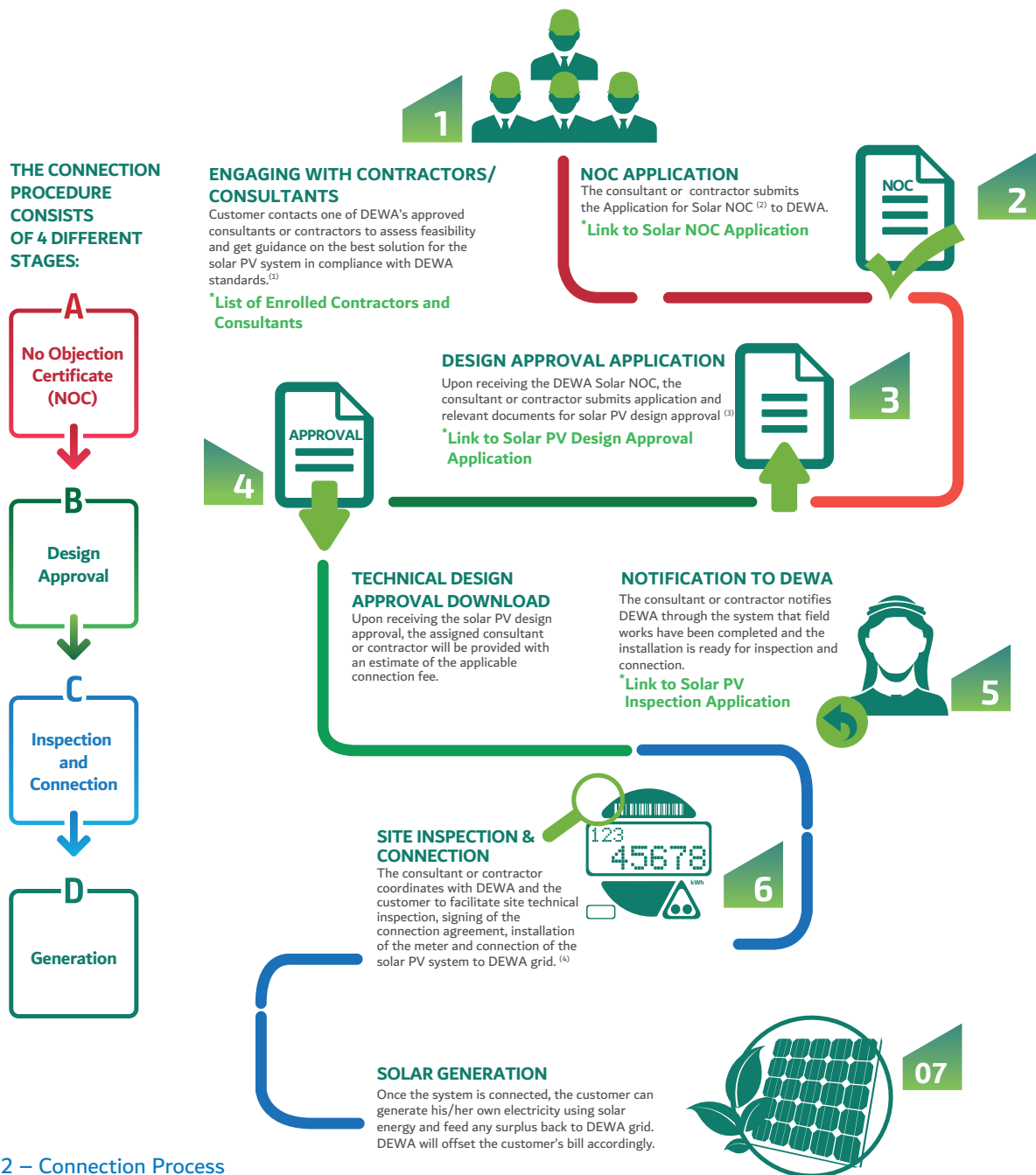

Figure 2 – Connection Process

1. The consultant or contractor will act as your agent and will advise you on the best possible solution for your system .
2. The capacity installed cannot exceed the applicable share of the Total Connected Load as per the Shams Dubai Connection Conditions, Section 2.2 "Limits to capacity of Renewable Generators". Moreover, DEWA may impose a lower threshold should it be justified by technical limitations related to the integration of your PV system into the power distribution grid.
3. A number of technical documents need to be submitted to DEWA, such as the site plans, system design plans and details of the proposed equipment, compliance with DEWA regulations.
4. For systems with installed capacity over 400kW, the cost of some dedicated equipment for grid integration might be added to the standard connection fee. A budgetary estimate of such cost can be provided in the early stages of application process upon request, provided the consultant or contractor submit the required technical information
5. For installation above 100 kW, plant performance test should previously be completed successfully.

3.1 Engaging with Consultants/Contractors

3.1.1 Project Preparation

Once the decision is made by the customer (future producer) to invest in solar PV plant, it is recommended that the future Producer request an offer from a Consultant / Contractor and advise on the best possible solution for the Solar PV system in compliance with DEWA regulations. This offer is to be agreed between the producer and consultant/contractor

The **Technical** part should contain:

- High level electrical design/ structural drawings of the installation;
- Proposed installed capacity in kWp;
- Technology proposed and system working principle;
- Estimation of the electrical production for one year, with a detailed indication of loss diagram;
- Comparison to the expected electricity consumption (based on past consumption); and
- Warranties from the Manufacturers and Contractors.

The **Financial** part should contain:

- Price for the equipment;
- Cost of installation;
- Installation monitoring system (if required by the Standards or optional if not); and
- Maintenance plan.

3.2 Consultant/Contractor applies for Solar PV Connection

3.2.1 Enrolment

The first step, in case of a new Electrical & DRRG Solar PV Consultant / Contractor, is to register with DEWA e-Service through DEWA website at www.dewa.gov.ae, that is exclusively designed for Electrical & DRRG Solar PV Consultant/Contractor (hereinafter Applicant) to apply and track the application online.

Both the Electrical & DRRG Solar PV Consultant and the Contractor have to own a standard Trade License issued by the Department of Economic Development, Government of Dubai.

Moreover, Electrical & DRRG Solar PV Consultant/Contractor has to be accredited for the installation of Renewable Resources Generating plants.

3.2.2 Solar NOC Application

The Applicant has to submit through DEWA website an application form for Solar PV Connection in order to obtain from DEWA the DRRG Solar NOC (No Objection Certificate).

The following information is required in the NOC Application Form:

- Identification of existing electricity connection (Contract Account No., ID of the meters at the Points of Connection);
- Project Details;
- Electricity Demand Details (information related to captive consumption);
- Electricity Production Details (information related to solar generation);

- Owner authorization form (if requested by DEWA, a copy of the competent Authority/Entity (i.e. Dubai Municipality, Trakhees, etc.) approved affection plan/site original scale shall also be submitted);
- Short circuit contribution from the plant to the network;
- Filled up DRRG Solar NOC application form (Excel sheet format), specifying capacity proposed at each Point of Connection with the concerned existing total connected capacity ;
- Foreseen date for completion of the plant and connection to the network.

In case of positive answer from DEWA, the Applicant receives the Solar NOC.

This Solar NOC is mandatory prior to obtaining a Building Permit from the competent Authority/Entity (i.e. Dubai Municipality, Trakhees, Etihad Esco etc.) and to start construction activities at site.

3.2.3 Solar Design Approval application

The Design Approval Application Form must be submitted through the DEWA website.

The purpose of obtaining the Design Approval is to carry out the electrical installation work complying with DEWA regulation for electrical installations:

- DEWA Regulations for Electrical Installations, 1997 Edition;
- DEWA Power Supply Guidelines for Major Projects,
- DEWA Distribution Substation Guideline,
- DEWA Design Requirements & Guidelines for MV (11kV-22kV) supply,
- DEWA Standards For Distributed Renewable Resources Generators Connected To The Distribution Network.

The following documents and information are required: (Application Assessment)

- Design assessment form (XLSX format)
- Detailed plan of project electricity connection points;
- Building Permit from the competent Authority/Entity (i.e. DM, Trakhees, Etihad Esco etc.) for solar installations (can be submitted upon the stage of inspection without interconnection)
- Total connected load & maximum demand schedules at each connection point;
- Production details (kWp and kWh per annum);
- Single line diagram, with details of metering and protection system (relays, CTs and VTs when adopted, e.g. for MV network connections);
- Copy of site setting out plan showing details of proposed works, PV panels layout, meter location(s), etc.;
- Installation Details of proposed solar generation meter, PV panels, inverters, MDBs/SMDBs etc.;
- Details on PV modules, for each kind used in the plant (Manufacturer, model reference, efficiency, warranty years for manufacturing defects, peak capacity per single PV module [Wp], surface per single PV module [m²], orientation (South= 0°, East= -90°, West=90°), tilt angle (inclination with respect to horizontal), number of modules of this type);
- Compliance (to applicable Standard) certificate of the modules;
- Details on Inverters, for each kind employed in the plant (number of inverters of each type, manufacturer, model reference, compliance with the Inverters approved by DEWA, warranty years, rated AC power, nominal power factor and adjustable range, maximum DC input voltage, AC output voltage, connection phases, synchronization method with DEWA network, environmental protection rating (IP), means to avoid dust penetration in the installation room (if any);
- Harmonics Assessment Report of Shams Dubai Project Design with 3-ph LV connection. This shall be obtained by applying Hab-Reeh interactive web service (Location: www.dewa.gov.ae/en/builder/shams-dubai-guides-tools/harmonic-assessment-hab-reeh)
- Certificate of compliance to DEWA and International Standard certificate of the inverters (if not in the list of the already approved ones);
- Details of Interface Protections (number, manufacturer, model reference, compliance with the protections approved by DEWA);
- Certificate of compliance to DEWA and International Standard Certificate of the interface protection (if not in the list of the already approved ones);

-
- Plan of substation location (if requirement of substation is indicated in DEWA's building NOC or if a MV connection is needed)
 - Ground Floor and/or Typical Floor Layout indicating Location of Electrical rooms, MDB / SMDB, DB, Inverters, etc.;
 - Dimensional layout of electrical RMU rooms, LV switch rooms with arrangement of the panels, metering rooms or enclosures;
 - Wiring layouts;
 - Load distribution schedules;
 - Harmonics currents spectrum generated by the RRGUs including Total Harmonics Distortion (THD);
 - Structural drawings (mechanical structural drawings submitted to the concerned authorities as part of approvals shall be submitted to DEWA for reference);²
 - Green Building Regulation implementation document; (if applicable)
 - Other drawings/technical specification as applicable;
 - Explicit acceptance and agreement to the terms and Conditions of the Connection Agreement; and
 - Operation and Maintenance criteria and main planned actions.

In some cases, particularly when the new RRGPs have relevant power capacity, it may be connected to the MV Distribution network or to a LV feeder, if possible. If the capacity of the new RRGPs exceeds the feeder technically acceptable limits, a new substation might be envisaged by DEWA.

The following situations may then be possible:

- PV plant with Maximum Capacity $P_{MC} \leq 400$ kW to be connected to an LV feeder, but where a new DEWA MV /LV substation is required in Customer's premises (e.g. inside a compound).
- PV plant with Maximum Capacity $P_{MC} > 400$ kW to be connected to a new DEWA MV/LV substation.
- PV plant with Maximum Capacity $P_{MC} > 400$ kW to be connected to a private MV substation and then to a new DEWA MV RMU substation.

If the requirement of one or more substations is indicated in DEWA's Building NOC and, if a connection to the MV network is needed (Maximum Capacity of the PV plant > 400 kW), the Applicant shall submit all the information for the approval of each of the substations, providing the information required by the DEWA Distribution Substation Guideline.

In cases where the electrical equipment of the substation (MV and LV panels, meters and so forth) will be the property and responsibility of DEWA, then DEWA will take care of the installation either with own technicians or appointed accredited Contractors. The Applicant will be required to complete the Civil works, including the substation building and the cable trenching.

For the construction of MV private substations, the Applicant has to be aware of the following:

- DEWA makes use of 3x240 or 300 mm² XLPE/PVC/SWA/PE aluminium/Cu cables complying with IEC 502 for supplying power to 11kV panels incomer.
- The Customer incomer should be suitable for termination of the above mentioned cables with heat shrinkable type cable terminations. The terminations should be carried out by a qualified/approved joiner (name and details to be submitted along with other relevant documents). The termination kits for the same should be provided and installed by the Contractor.

² Not for DEWA approval, but only for information purposes. These drawings must be accompanied by a declaration signed by the civil designer on the compliance of the structures to the in force laws and rules.

-
- The Electric supply shall be released by DEWA at Customer's circuit breaker/s point i.e. DEWA ownership of point of supply will be at the incomer of the breaker/s.
 - The Contractor must obtain written acceptance from the Producer to carry out the maintenance of the MV switchgear and downstream equipment, which will be procured by the Contractor himself, shall be done by the Producer in the future. This declaration shall be forwarded by the Contractor to DEWA before commencement of works for the project.

The duly approved drawings may then be collected by the Applicant.

3.3 Technical Design Approval Download and Estimate of Applicable Connection Fees

3.3.1 Payment and Execution

The Applicant receives from DEWA the estimate of the Solar PV connection fees based on the approved drawings and the comments in the Building/Solar NOC (the remarks shall indicate whether a substation is needed or not).

The Applicant then pays the connection fees and DEWA will carry out all the necessary interventions on the network, in order to make the connection feasible.

Once the connection fee is paid, the Applicant can commission the construction of the plant.

3.4 Notification to DEWA by Consultant/Contractor for Inspection and Connection

3.4.1 Application for Mechanical Inspection

Once the laying of the PV modules is completed, the Applicant needs to ensure Mechanical Inspection is completed (Mechanical Completion) by the competent Authority/Entity (i.e. Dubai Municipality, Trakhees, Etihad Esco etc.) **before initiating** the electrical works. This will assure that the modules, layout and fixation comply with the applicable standards and safety rules in Dubai. In case of a positive result, the Solar PV construction can proceed with the electrical works.

3.4.2 Application for Inspection and Connection and Post-Connection steps

Application for Inspection

When the PV is installed and all civil and electrical works are completed, the Applicant submits through DEWA website an Inspection Application. This application has to be submitted for all plant sizes.

Before the application, it is mandatory to have the following documents prepared:

- Dubai Municipality approved affection Plan/other utilities affection plan;
- Building Completion Certificate from Dubai Municipality;
- Owner's Passport copy/Trade License copy;

- Authorization letter from the owner to his representative;
- A copy of DEWA approved Design and Shop Drawings;
- A copy of the As-Built Drawings;
- A copy of DEWA approved Connected Load/Max;
- Captive load Demand Details;
- Solar PV Equipment Details;
- Inverter Compliance Certification;
- Interface Protection Compliance Certification;
- Module Certification;
- Owner's NOC (if tenant application); and
- Building NOC (6 month validity from the date of issue) with submission of:
 - Approved Substation location and size; and
 - Setting out Key Plan showing the Electricity Metering Location.

For MV connections with private substations, the following additional information is required:

- Revised/updated copy of a single line diagram with details on metering and protection system;
- Undertaking letter stating that the load on each feeder shall not exceed 3MW (175A) in normal operation and 6MW (350A) in case of contingency if the adjacent feeder fails;
- Real measurement of harmonics shall be conducted after full commissioning of the equipment and to be submitted to DEWA for verification to ensure that the values are within prescribed limits;
- Step by step relay setting calculations. The relay co-ordination shall be made on maximum fault current and the grading margin shall be kept at 0.300 seconds between DEWA ends to private party's panel end;
- Owner's undertaking stating "Our equipment are suitable to energize in line with DEWA network system " and confirm that the relays are set as per DEWA approved setting;
- HV cable Jointer's list in details (approved by DEWA);
- Names and telephone numbers of contact person for the project who should be available to contact on a 24 hour basis;
- Name of technical staff, competent in the switchgear operation and issuing of permit stating that cable is safe for work and also ensure no one, will operate during test & repairing time.
- Factory & Site test report for the transformer/breaker, MV cable, etc. and test result for the transformer inrush unbalance current to be forwarded for verification;
- Operation philosophy (interlocking details) -to be incorporated in the single line diagram; and
- All catalogues for CT, VT, relay & motor.

Inspection and installation of the meter(s)

In case of a positive result of the site inspection, DEWA installs the meter(s).

During this inspection, DEWA supervises the tests and the measurements on the installation made by a Test Engineer appointed by the Contractor.

In case of construction of a new DEWA substation, the Substation Inspection Request is also sent through DEWA website by the Applicant after completing the civil works of the proposed substation as per the Trench Layout drawing.

After the meters have been installed, the RRGP can be energized. For plants connected to the Medium Voltage distribution network, it is particularly important that this operation be supervised by Engineers. The same Engineers will take care of all the necessary provisions for the energization of the ring to which the plant is connected (manoeuvres to be made on the DEWA Distribution Network), and eventually witness the closure of the RRGP main circuit breaker.

Testing with Interconnection to the grid

After the plant has been connected to the network, a number of tests with the aim of verifying the correct behaviour of inverters, protections as well as the electrical checks on the installation, need to be carried out.

For all the plants, these tests shall be carried out by a certified Test Engineer. The results of these tests will be collected into a Technical Dossier to be submitted to DEWA for approval. In case of plants with $P_{MC} \geq 100$ kW or connected to MV network, this approval is a prerequisite to the execution of the Performance Tests. For plants below 100 kW, no further tests or inspections are required, so the Final Inspection Report will be prepared by DEWA and Connection Agreement issued (see below).

No DEWA supervision is needed during this testing stage.

Performance Tests and Post Connection Inspection

For PV plants of Maximum Capacity larger than or equal to 100 kW, DEWA issues a Preliminary Authorization to let the Applicant execute the performance tests as indicated in the Connection Standards. The tests will be carried out by a Test Engineer or by an appointed system integrator engineer who has to be commissioned by the Applicant. Upon the finalization of the tests, the Applicant submits a copy of the testing documents (As-Built Drawings and the Technical Dossier) and applies to request the Post-Connection Inspection through the DEWA website.

DEWA executes the final site inspection in order to:

- make the final checks on the installation, if necessary;
- verify the correct behaviour of the meters; and
- supervise the performance tests as carried out by the Applicant, in order to verify the efficiency of the plant.

In case of positive result of the inspection, DEWA Connection Services Department issues the Final Inspection Report, which certifies that the installation is compliant with DEWA rules and that the electricity production can start (after the signing of the Connection Agreement).

Final steps: O&M Contract, Insurance and Connection Agreement

A regular Operation and Maintenance (O&M) Contract has to be provided by the Applicant. The Contractor and/or Consultant will inform the Producer about the requirements of the plant in terms of O&M. An O&M manual shall be made available to the Producer, in order for the Producer to correctly and safely operate the plant, if adequately skilled, or to transfer the operating obligations to an appointed Contractor. As stated above, the Contractor services are required for the Maintenance³. DEWA will verify the availability of this manual in the inspections.

The Producer also needs to provide DEWA with a statement stipulating that he is aware of the Operation and Maintenance needs of the plant, indicating who will be responsible for the O&M.

It is also strongly recommended to have an insurance for the PV system as specified in chapter 4 (the system can be included in the Building insurance or a specific insurance may be stipulated for the PV system).

Once the Final Inspection Report has been issued, the Connection Agreement will be signed and submitted to DEWA by the producer.

³ This may also be different from whom has constructed the plant

The Connection Agreement encompasses both the technical and commercial aspects of the connection, addresses the Standards and Minimum Technical Requirements and specifies the Terms and Conditions including the constraints on quality of supply, in accordance with the defined rules.

The DRRG connection conditions apply. The official production start date and time that will be utilized for Net Metering purposes, is thus the date of the Connection Agreement.

3.5 Start of Production

After the official start of the electricity production, DEWA will read the production meter on a monthly basis. DEWA will thus monitor how much electricity the system has produced (Metering Process), calculate the economic amount of electric energy supplied based on the defined price rules (Settlement Process, see also General Terms and Conditions regarding net metering) and prepare the bill (Billing Process).

4 DEFINITION OF THE RESPONSIBILITIES

The purpose of this Chapter is to define a list of obligations and entitlements that each one of the parties involved in the building and PV plant network connection has to comply with.

The limits of responsibility of the below are outlined:

- DEWA;
- the Customer/Producer (as owner of the plant);
- the Consultant of the Producer;
- the Contractor (as appointed by the Producer); and
- the Manufacturers of PV products and equipment.

Please note that the Applicant may be either the Consultant or the Contractor. The limits of liability, as specified for the Consultant, may then apply also for the Contractors, if they are also involved in the design of the plant.

4.1 DEWA

DEWA shall be responsible for:

- operating and maintaining a secure, reliable and efficient electricity distribution network, in order to be able to receive the power produced by the Renewable Resources Generating Plants;
- granting the connection to the network to the Producers, for applications compliant with applicable regulation and procedures;
- conducting the site and plant inspections as defined above;
- undertaking any possible provisions to clear a fault in the distribution network in the shortest time, within the limits indicated in Table 4 of the Standards⁴. DEWA shall not be liable for the loss of production that the RRGPs connected to the Distribution Network will undergo in case of disconnection following the intervention of the Interface Protection⁵.

Ownership Boundaries:

- the boundary between DEWA and the Producer is the Connection Point as indicated in the connection schemes in Appendix A;
- the respective ownership of Plant or Apparatus shall be recorded in the Connection Agreement between DEWA and the Producer in the form of a diagram.

4.2 CUSTOMER/PRODUCER

- The Producer must enter into a Connection Agreement with DEWA. The Connection Agreement encompasses both the technical and commercial aspects of the connection, addresses the Standards and Minimum Technical requirements and specifies the terms and conditions including the connection fee, net metering criteria, use of system and quality of supply in accordance with the DEWA Standards.
- The Producer shall indemnify DEWA and accept liability for safety and supply quality issues that occur when the PV Plant is operating.

⁴ The Producer must be aware that these clearing times may be higher than the time setting in the Interface Protection and in the disconnection area of the LVRT curve, which means that the plant may disconnect from the network. This is because the purpose of the Interface Protection settings and inverter's LVRT feature is to permit the RRGPS to effectively ride through faults occurring in the High Voltage network, because of the detrimental effects that a disconnection of these plants would have in this case.

⁵ In order to allow the automatic re-connection of the plant to the Distribution Network once the disturbance in the network has been cleared, proper automatic re-closure schemes may be found in the Standards.

The Producer shall be responsible for:

- the choice of any of the PV Plant equipment;
- the installation, operation and maintenance of all the PV Plant equipment;
- ensuring that there is a safe system of work for all representatives that are involved in the PV Plant construction, in compliance with all applicable standards and statutory requirements;
- the protection and safety of the generating facility or the generating units, respectively;
- the reliable protection of his/her plants (e.g. short-circuit, earth-fault and overload protection);
- the PV Plant insurance against damages by storm, hail, lightning, over voltage, theft, fire or any other external hazards.

4.3 CONSULTANT

Consultant's responsibility and liability are defined by the laws in force.

In particular, the Consultant shall be responsible for:

- carrying out the application process on behalf of the Producer as described above;
- the correct choice of equipment;
- correct consulting of the producer regarding all technical aspects.

4.4 CONTRACTOR

Contractor's responsibility and liability are defined by the laws in force.

In particular, the Contractor shall be responsible for:

- applying a safe system of work in the PV Plant construction, in compliance with all applicable standards, regulations and statutory requirements;
- proposing to the Producer adequate and certified PV equipment;
- building the installation in compliance with all applicable technical standards⁶;
- appointing a Test Engineer to perform tests on the plant.

As stated above, the limits of liability as specified for the Consultants apply also for the Contractors when their services extend to include consultancy services and the design of the plant.

4.5 MANUFACTURERS

Manufacturers' responsibility and liability are defined by the laws in force.











The manufacturers shall in particular be liable in case of delivery of false certificates of compliance for the PV products (modules, inverters, cables, protections, and so forth).

⁶ The Contractor will have to deliver a declaration of compliance of the plant to these standards.

APPENDIX A: CONNECTION SCHEMES

A.0 - General provisions

The connection schemes for the different situations are represented hereinafter, with the following meaning of the symbols adopted:

LEGEND	
	CIRCUIT BREAKER (CB)
	SWITCH DISCONNECTOR WITH FUSES
	EARTH LEAKAGE CIRCUIT BREAKER (CB)
	CURRENT TRANSFORMER (CT)
	TOROIDAL CURRENT TRANSFORMER
	VOLTAGE TRANSFORMER (VT)
	LOAD
	POWER CONVERSION SYSTEM
	PHOTOVOLTAIC ARRAY
	TRANSFORMER
	BIDIRECTIONAL ENERGY METER (4 QUADRANTS) - SMART METER
M1	MAIN ELECTRICITY METER: INJECTION TO / CONSUMPTION FROM DISTRIBUTION NETWORK
M2	RRGP ELECTRICITY METER: PRODUCED PV ENERGY

A.2 - LV2 Connection Scheme - One inverter $10 \text{ kW} \leq P_{MC} \leq 20 \text{ kW}$ (Interface Protection external to the inverter)

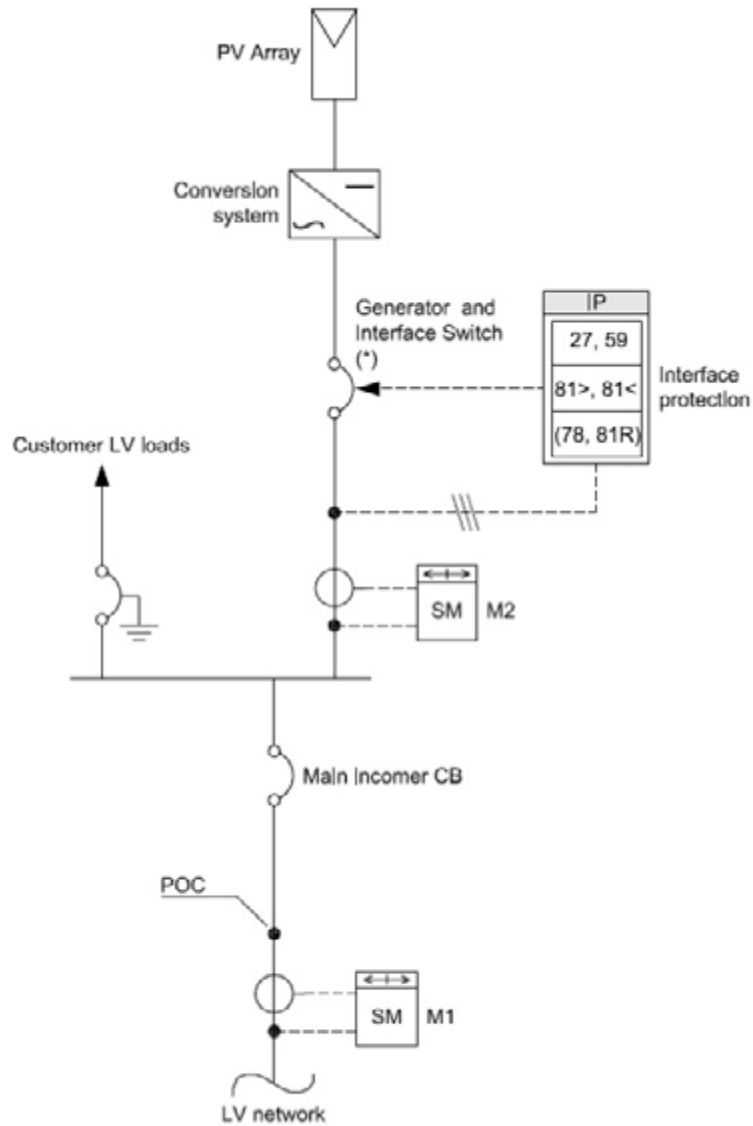

(*) Motorized CB operated by undervoltage release or Contactor

Note:

- Interface switch not embedded in the Inverter.

A.3 - LV3 Connection Scheme - Multiple inverter ($10 \text{ kW} \leq P_{MC} \leq 20 \text{ kW}$)

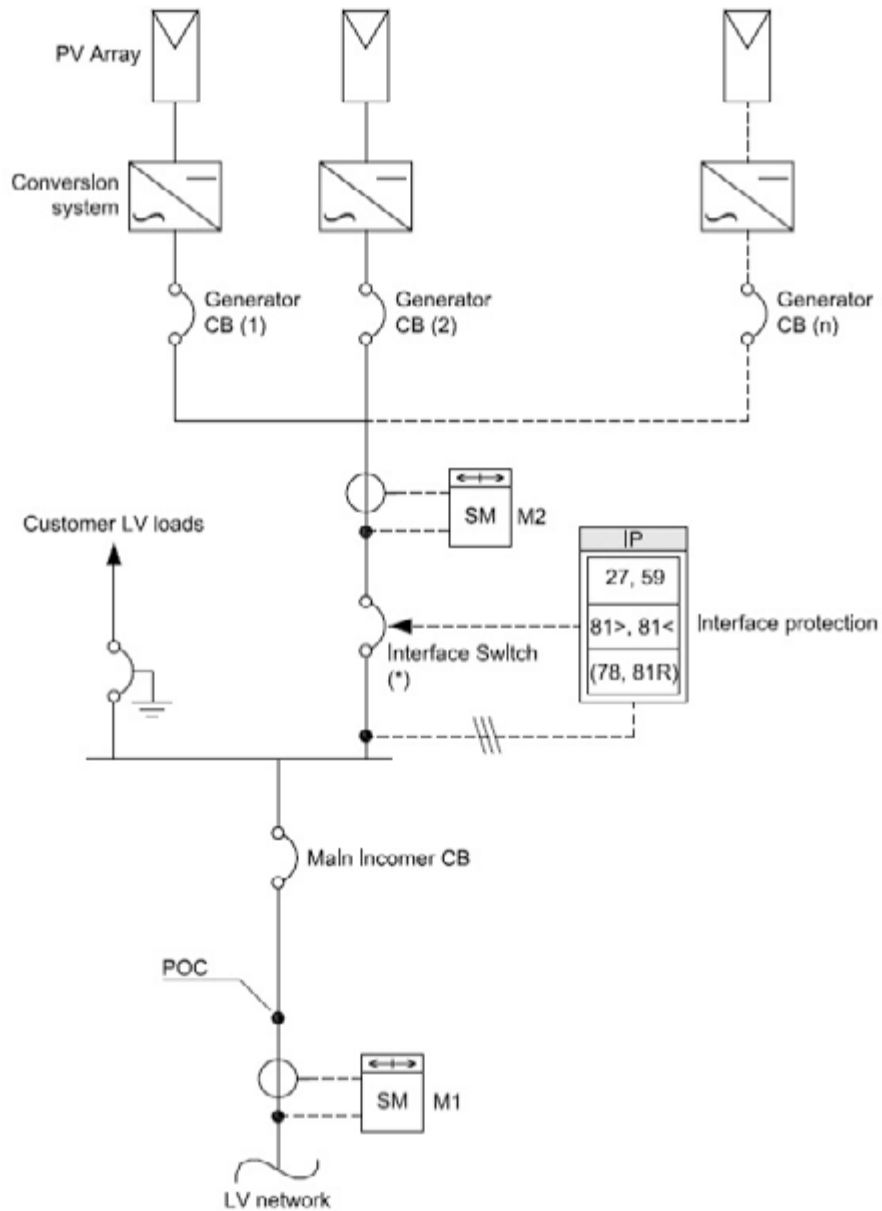

(*) Motorized CB operated by undervoltage release or Contactor

Note:

- Interface switch separated from Generator switch.

A.4 - LV4 Connection Scheme – Multiple inverter ($P_{MC} > 20 \text{ kW}$)

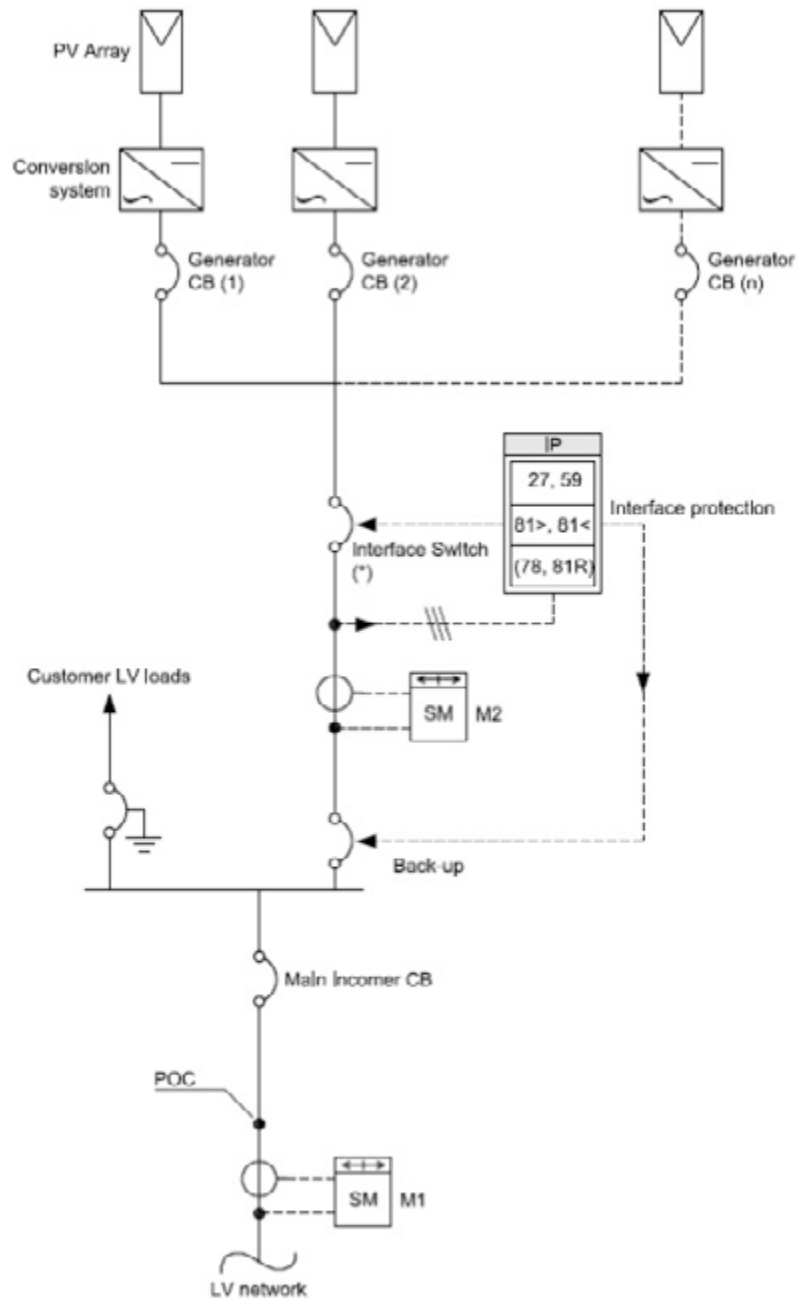

(*) Motorized CB operated by undervoltage release or Contactor

Note:

- General switch separated from Interface switch where the former acts as a back-up of the latter; and
- Interface switch separated from Generator switch.

A.5 - MV1 Connection Scheme - Interface Switch on LV side

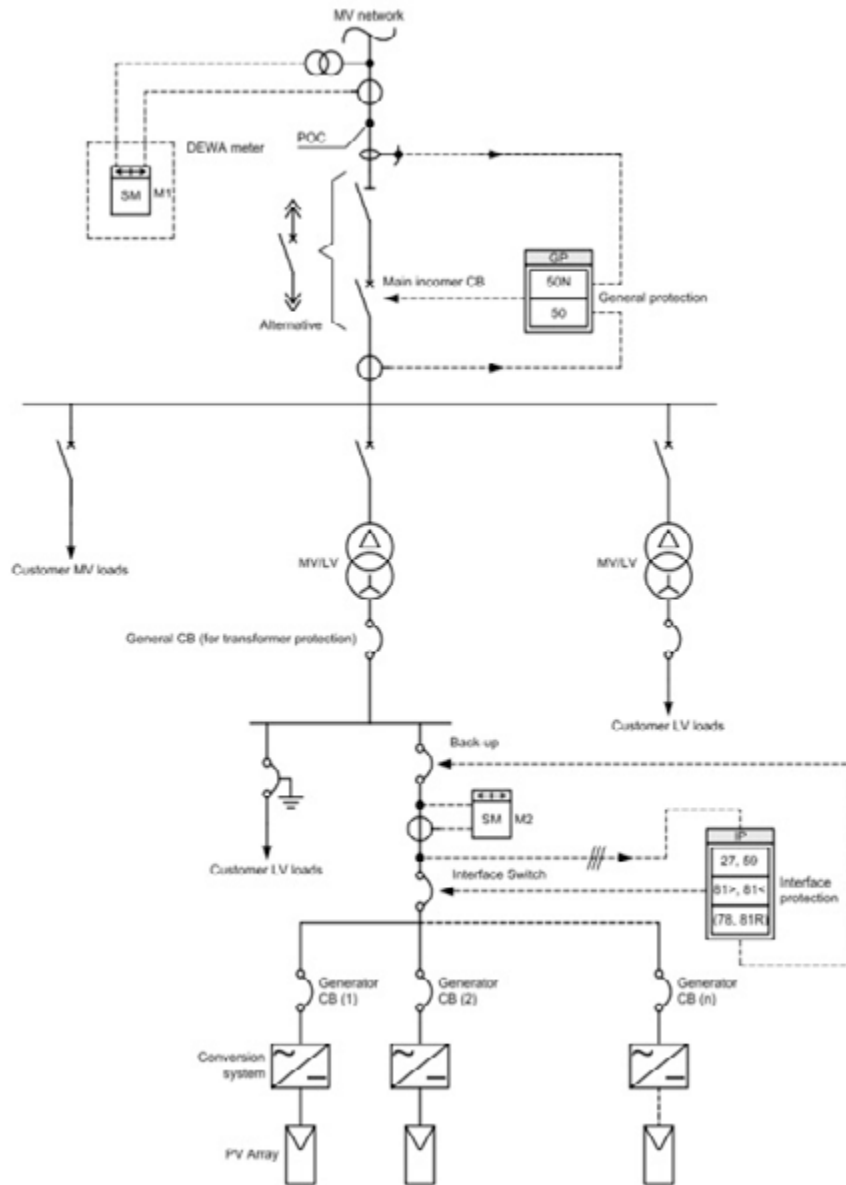

Note:

- Interface protection and Generator switches on LV side;
- Interface switch separated from Generator switch; and
- The number of transformers represented is entirely indicative.

A.6 - MV2 Connection Scheme - Interface Switch on MV side

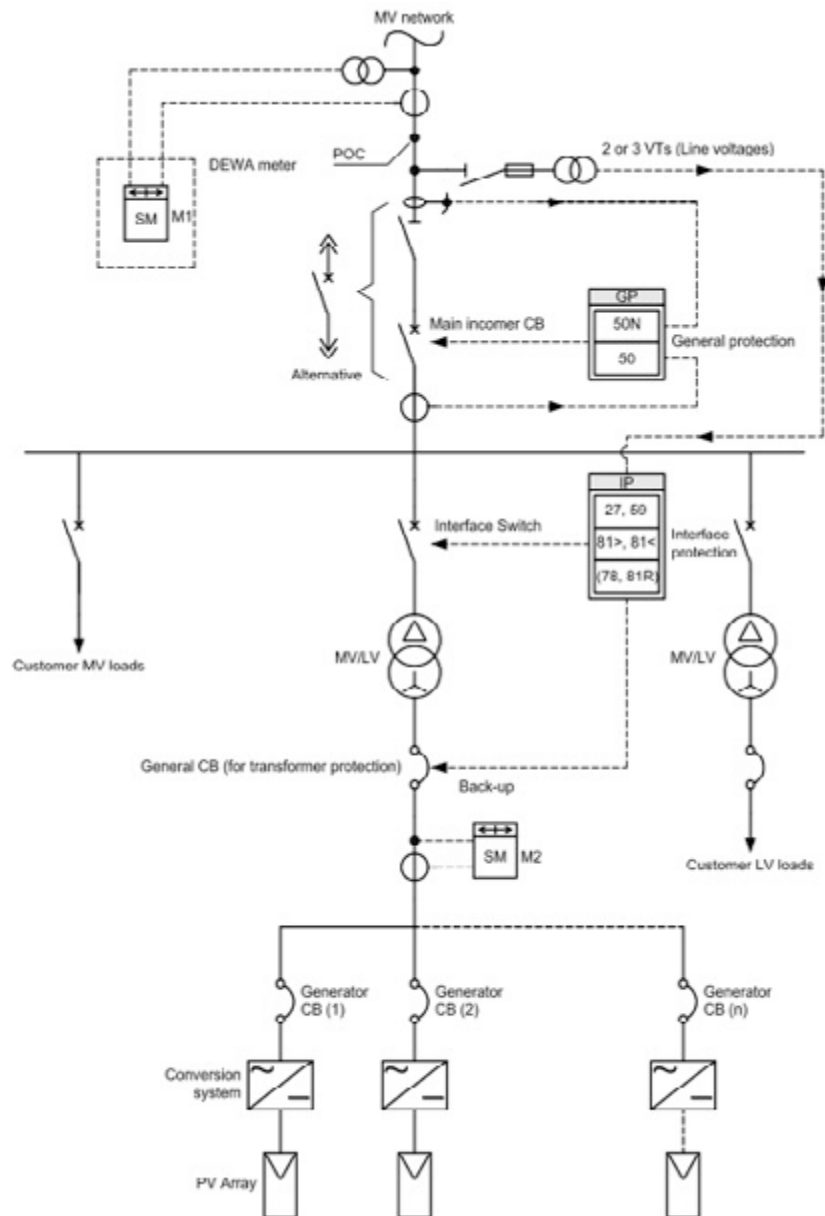

Note:

- Interface protection and switch on MV side;
- Back-up on the LV General CB (if no loads are derived at the LV side and PV plant connected via a dedicated transformer); and
- The number of transformers represented is entirely indicative.

For any further queries and clarifications on the DRRG Standards, please contact DRRG.Standards@dewa.gov.ae



 **DEWAOFFICIAL**
customercare@dewa.gov.ae | www.dewa.gov.ae



OFFICIAL SUSTAINABLE ENERGY PARTNER

Our Vision
A globally leading sustainable innovative corporation
P.O. Box 564, Dubai, United Arab Emirates
T: +971 4 601 9999